

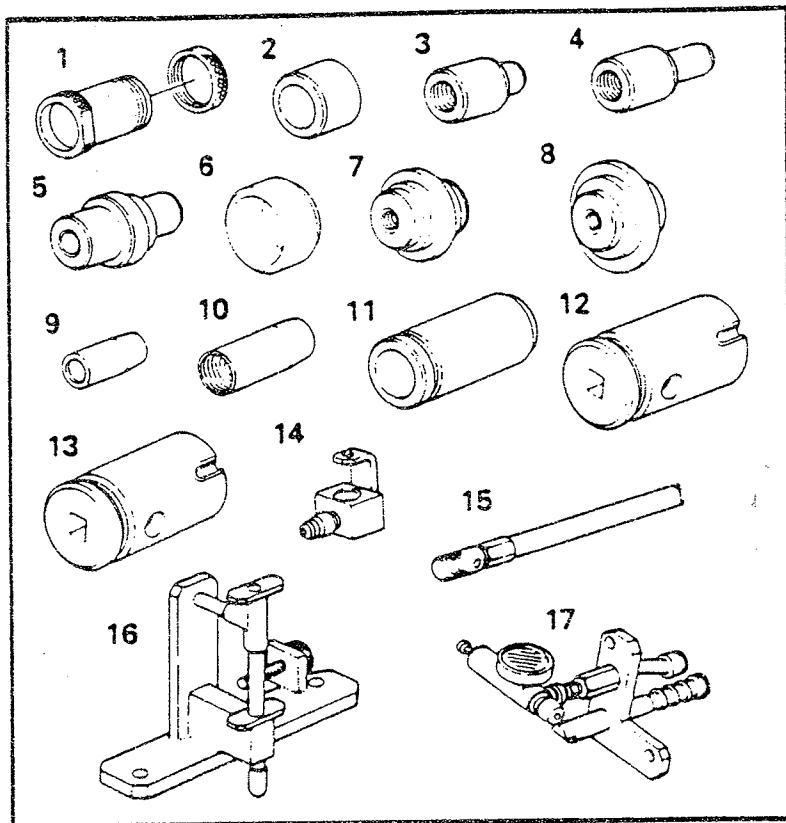

HESSTON

Service Tested & Approved

**3121
SERVICE
TOOL
KIT FOR 66
SERIES
TRACTORS**







CONTENTS OF 3121 KIT



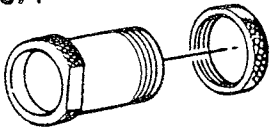
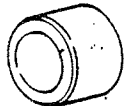
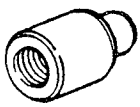
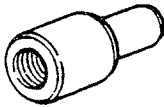

ITEM NO.	PART NO.	QUAN.	DESCRIPTION
1	700703031 (10371)	1	Pinion Bearing Positioning Tool
2	700703030 (10363)	1	Spacer Transmission Top Shaft Adj.
3	293838 (10364)	1	Installer Needle Brg. Draft Lever
4	293839 (10365)	1	Installer Needle Brg. Hydraulic Lift
5	293847 (10366)	1	Installer Brake Boot
6	293843 (10367)	1	Guide - Lift Cylinder Piston
7	293842 (10368)	1	Installer - Rock Shaft Seal
8	293850 (10369)	1	Installer - Final Drive Seal
9	293848 (10370)	1	Installer - Final Drive Seal
10	293834 (10372)	1	Protector - PTO Shaft Assembly
11	293836 (10373)	1	Protector - PTO Shaft Assembly
12	293837 (10375)	1	Wrench - Front Axle Nut
13	293519-1 (10376)	1	Wrench - Front Axle Nut
14	293849 (10377)	1	Adapter - Pilot Valve Leak Test
15	293844 (10378)	1	Wrench - Hydraulic Lift Adjustment
16	293845 (10380)	1	Draft Control Adjustment Tool
17	293846 (10381)	1	Draft Control Position & Adjustment Tool

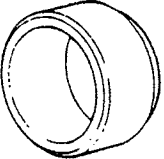
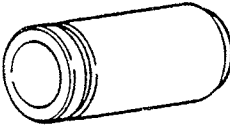

HESSTON

SPECIAL TOOLS

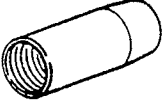
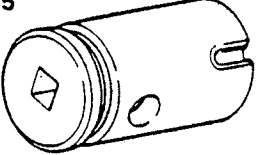
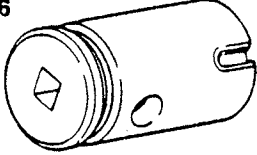
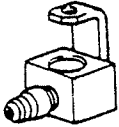
TOOL NUMBER	DESCRIPTION	APPLICATION
10371 700703031 	Pinion Brg. Positioning Tool Used to gauge shims required for bevel pinion adjustment. 1 - 10362 Body 2 - 10261 Nut	466 - 766 480 - 1880
10363 700703030 	Spacer Used to adjust transmission top shaft	466 - 766
10364 293838 	Installer Used to install needle brg. for draft lever	466 - 766
10365 293839 	Installer Used to install needle brg. for hydraulic lift.	466 - 766
10366 293847 	Installer Used to install brake boot in housing	466 - 766
10367 293843 	Guide Used to install piston in lift cylinder	466 - 766
10368 293842 	Installer Used to install rock shaft seal	466 - 766
10369 293850 	Installer Used to install final drive seal & brg.	466 - 766

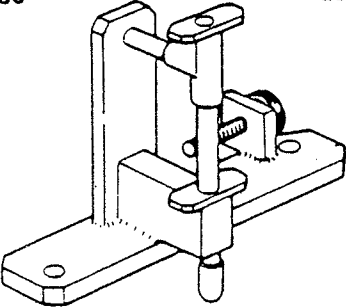
TOOL NUMBER	DESCRIPTION	APPLICATION
10370 	293848 Installer Used to install final drive seal & brg.	466 - 766
10372 	293834 Protector Used on P.T.O. shaft to protect seal when installing shaft.	466 - 766
10373 	293836 Protector Used on P.T.O. shaft to protect seal when installing shaft	466 - 766
10375 	293837 Wrench Used to tighten front axle nut.	466 & 566 DT
10376 	293519-1 Wrench Used to tighten front axle nut.	566 & 766 DT
10377 	293849 Adapter Used to check pilot valve	466 - 766
10378 	293844 Wrench Used to adjust Hydraulic Lift	466 - 766
10380 	293845 Draft Control Adj. Tool Used with 10381 to adjust draft control. 10383 - Fixture 10384 - Tee Draft Control 10385 - Rod 10382 - Screw Knurled Hd. 10386 - Washer Bevel (2 pcs.) 10387 - Lock Nut 1767 - Washer Flat	466 - 766



SPECIAL TOOLS

HESSTON

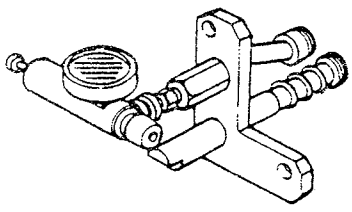
TOOL NUMBER	DESCRIPTION	APPLICATION
10381 293846 	Adjustor Position & Draft Control Used with 10380 to set draft control. 10388 - Fixture Assy. 10392 - Regulator & Gauge Assy.	466 - 766